

HYDRO SS 700

► HANGING SUMP

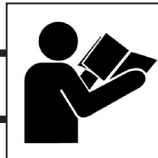

OPERATOR'S MANUAL



⚠ NOTICE

Read & Understand
Retain for Future Reference

Purchase Date _____ Model ID Number _____

Vendor Information _____

Notes

GENERAL SAFETY

The **Hydro SS 700** uses a high-speed component to atomize water, the following safety precautions must be observed at all times:



1. Read operator's manual carefully and thoroughly. Understand all safety warnings and instructions before attempting operation of the unit.
2. **DO NOT OPERATE THE UNIT DRY** (*FULL WATER SUPPLY IS REQUIRED IN THE SUMP*). Avoid permanent damage to the unit's sump pump.
3. Follow all local electrical and safety codes as well as the United States National Electrical Codes (NEC) and Occupational Safety and Health Act (OSHA).
4. Always operate Hydro SS 700 with its safety guards and housing securely in place.
5. Disconnect power before inspecting or servicing machine. Hydro 700 must be properly grounded as a precaution against possible electric shock. Check for correct voltage supply.
6. Keep cord away from heat, oil, sharp edges and moving parts. Replace damaged cords immediately. Damaged cords increase the risk of electric shock.
7. If use of an extension cord is necessary, use a heavy gauge 3 wire extension cord with a molded three-prong plug.
8. Keep hands and all objects from entering the path of the blade.
9. Install the Hydro SS 700 at seven (7) foot height or higher for added safety and optimum performance.
10. Do not use flammable liquids, caustic materials, or corrosive materials with the Hydro SS 700.
11. When servicing Hydro SS 700, use only identical replacement parts and follow instructions in the maintenance section of this manual. Use of unauthorized parts or failure to follow maintenance instructions may damage equipment or cause personal injury.

NOTIFICATION

WARNING

THE HYDRO SS 700 CAN BE AUTOMATED WHEN USED IN CONJUNCTION WITH A CONTROL. THE FAN MAY NOT APPEAR POWERED BUT COULD SUDDENLY BEGIN HIGH-SPEED ROTATION AS A FUNCTION OF THE PRESET CONTROL.

WARNING

HIGH-SPEED ROTATION, NEVER OPERATE UNIT WITHOUT THE HOUSING AND SAFETY GUARDS INSTALLED.

NOTICE

GROUND FAULT RECEPTACLES ARE STRONGLY RECOMMENDED AND MAY BE REQUIRED BY LAW.

UNPACKING

When unpacking your unit, locate the following:

- 1) Hydro SS 700-HS
- 1) Operator's Manual
- 5) Wire Ties
- 1) Service Allen Wrench (for Blade Assembly)

POSITIONING

Small structures

In applications requiring only one unit, install the unit anywhere along one end wall, propelling the fog upward and horizontally down the length of the structure. If there is forced ventilation, choose the intake end of the structure. The best location for automated controls is behind the fan at an easily-accessible level for monitoring.

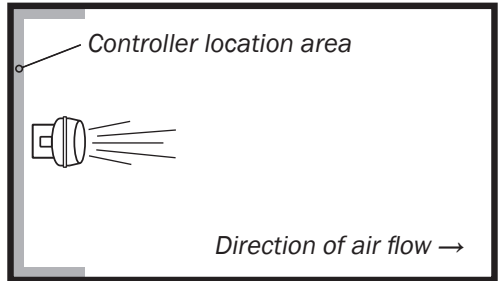

Large structures

Equally space the units within the structure. Lower humidity and/or cooling requirements can allow for greater distance between fans. Usually, the maximum distance between fans should be 20' from the side and 35' from the front. If the structure has forced ventilation, shift the fans closer to the intake end. The fans should always be propelling their fog with the direction of natural or forced air flow.

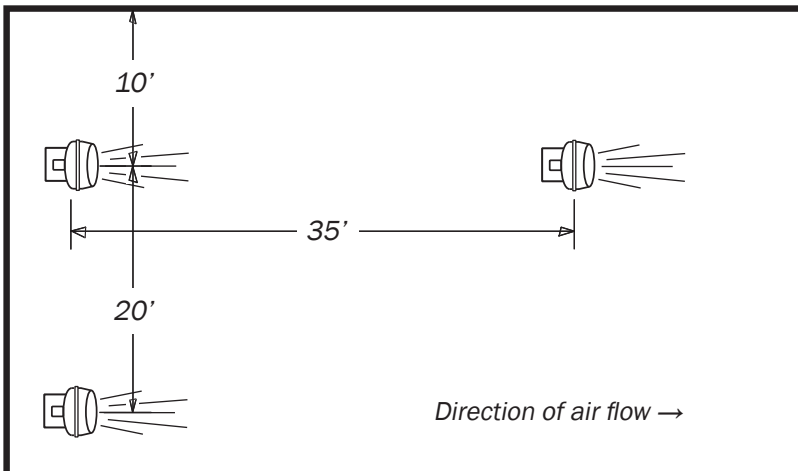

HANGING GUIDELINES

Where to Locate

NOTE: THIS UNIT IS SPECIFICALLY DESIGNED TO BE HUNG

Mount the fan high overhead in the largest available open area. As a general rule, the higher the better when mounting your fan. Allow one foot above the unit and adequate room in front of and below the fan for the unobstructed propulsion of the fog.



Mount the fan near the intake end of a ventilated structure and propel fog in direction with air flow. In structures with no ventilation, install the unit at the largest, most open end and propel the fog towards the opposite end.

Utilize the pivoting fogging head in order to maximize the unit's performance.

DO NOT propel the fog into the wind or direction of airflow.

DO NOT pivot the fogging head to propel fog at a sharp downward angle.

DO NOT cramp the fan in tight spaces or skinny aiseways.

DO NOT mount the fan near the ground or underneath tables or benches. This would result in a high loss of fog onto the ground, though it would not cause mechanical harm to the unit.

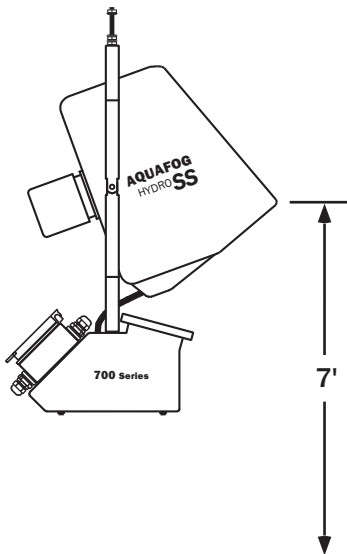

Pivot Feature:

For best results, pivot the fogging head between 15° and 30° up from the horizontal position.

OSHA regulations require unprotected fan blades to be mounted 7' or higher from the working surface.

INSTALLATION

Connect Water Supply:

Hydro SS units come equipped with a standard garden hose connector and 1/4" water line tubing. Simply connect to an available hose bib. Turn water on and allow a few minutes for the unit to fill. Remove sump lid to observe if unit fills properly. When the sump is full, the float valve should automatically stop water flow and refill it when necessary.

To trim water line. Remove 1/4" tubing from the hose connector by applying pressure to the retaining clip and pulling on the tubing. **See Fig. 1** Trim and push tubing back into the connector to secure.

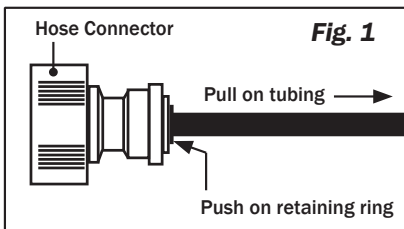

Insert Drainage Line:

Slip the drain tube into the black fitting leading to the sump box. **See Fig. 2**

Connect Power Supply:

Plug directly into a properly grounded receptacle. If equipped with a Humidistat, Thermostat, or Cycle Timer Control, plug the control into a receptacle and then plug the fan into the female side of the control's pre-wired plug. **See Fig. 2**

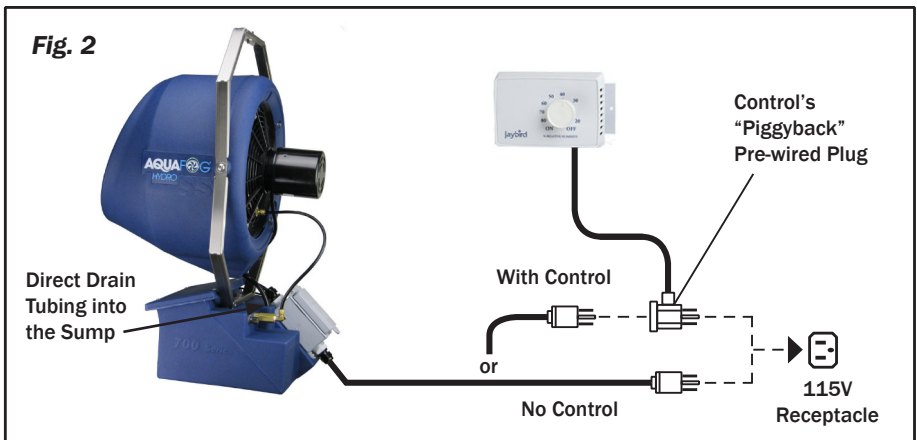

OPERATION

Fog Output

After the unit has been plugged in and the water turned on, you can adjust fogging output with the quarter turn flow control valve located at the back of the unit. The valve is fully open when the lever is horizontal and fully closed when the lever is pointing 90° up. You may also adjust it anywhere in between.

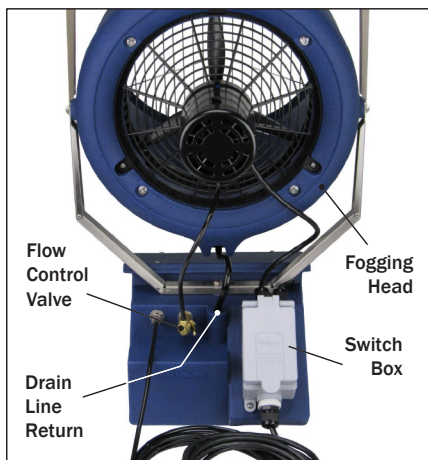

MAINTENANCE

Lubricate Motor: Remove two blue plugs at the top of the motor. Apply 4-5 drops of light grade petroleum based oil at each bearing location 1 to 2 times a year or as needed. Replace blue plugs. **See Fig. 3**

Cleaning Blade Assembly: After removing the blade assembly, remove the stainless plate and O-ring. Soak the blades in CLR for about one hour, scrub clean and rinse off with water. Carefully check the small holes leading into passageways that extend the length of each blade. **See Fig. 4** When clean, test by blowing air through each blade.

Clean Pump and Sump: Periodically clean debris from inside the sump area and nearby the pump. If you need to clean inside the pump, the cover easily snaps off. **See Fig. 5**

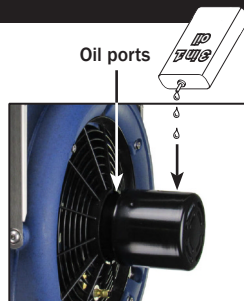

Fig. 3

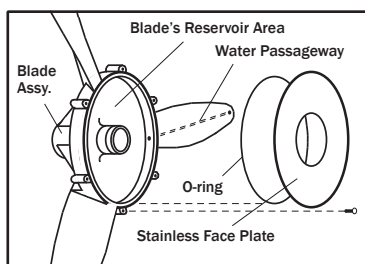

Fig. 4

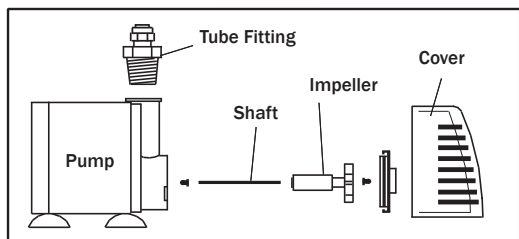

Fig. 5

Winterizing: Protect the unit from winter damage. When storing unit in freezing temperatures, be sure all fluid is drained from the unit.

TROUBLESHOOTING

Issue

Corrective Action

INITIAL START-UP

- | | |
|----------------------------|---|
| 1. Fan Blade Does Not Spin | 1. Check power supply. Toggle switch ON is up position. If using a controller, try bypassing it and plug unit directly into a power outlet. Check for a faulty power cord. |
| 2. No Fog but Blade Spins | 2. Make sure sump is properly filled with water, this takes a few minutes. After sump is full, turn unit ON and Open flow control valve (horizontal position is full open). Check units sump pump. |
| 3. Hard To See Fog Output | 3. As fog evaporates, it becomes transparent. Dry air and propulsion evaporates fog quickly. As humidity increases, evaporation slows and fog becomes more apparent. A dark background helps to see the output. |

SPORADIC or NO FOG

- | | |
|-----------------------------|---|
| 1. Stiff/Locked Motor Shaft | 1. Remove blue plugs and lubricate motor bearings while manually rotating shaft back and forth until loose. |
| 2. Bad Motor | 2. If motor smells, doesn't start (with a direct power supply) or shaft will not loosen up, replace motor. |
| 3. Not Enough Water | 3. Sump may not be getting water fast enough. Check float valve assembly. Check water line pressure and any kinks in water line tubing. |
| 4. Worn/Bad Sump Pump | 4. If sump and float valve checks out good, check the sump pump electrically and mechanically, replace if needed. |
| 5. Clogged SST Feed Tube | 5. Remove Feed Tube and ream with a small wire. Clean and reinstall. |

POOR QUALITY FOG

- | | |
|---------------------------|--|
| 1. Clogged Blade Assembly | 1. Remove and clean out the rear reservoir and the blades' passageways. |
| 2. Misaligned Feed Tube | 2. Adjust feed tube so its water stream flows into the blades rear reservoir. |
| 3. Stiff Motor Shaft | 3. Remove blue plugs and lubricate motor bearings while manually rotating shaft back and forth until loose. |
| 4. Loose Blade Assembly | 4. If the blade can spin without motor shaft, reposition the blade and tighten the setscrew on the flat of the shaft, replace assembly if necessary. |

FAN DOES NOT SPIN

- | | |
|-----------------------------|--|
| 1. Stiff/Locked Motor Shaft | 1. Remove blue plugs and lubricate motor bearings while manually rotating shaft back and forth until loose. |
| 2. Bad Motor | 2. If motor smells, doesn't start (with a direct power supply) or shaft will not loosen up, replace motor. |
| 3. Bad Controller | 3. Check controller for loose connections, test unit's motor and controller independently with a direct power supply for process of elimination. |

MOTOR OVERHEATING

- | | |
|-----------------------------|---|
| 1. Stiff/Locked Motor Shaft | 1. Remove blue plugs and lubricate motor bearings while manually rotating shaft back and forth until loose. |
|-----------------------------|---|

SERVICE & REPAIR

Atomizing Ring/Front Guard Assembly

Using a 3/8" nut driver or wrench, remove four 10-24 flange nuts located at the back of the housing. To remove and reinstall the assembly, it needs to be rotated horizontally in order to clear the lip of the front housing. **See Fig. 7.**



Fig. 7

Fan Blade Assembly

First remove the atomizing ring/front guard assembly. The blade assembly is now accessible and is secured to the motor shaft with a setscrew. Loosen the setscrew using 1/16" Allen wrench (provided) and carefully leverage blade assembly off the shaft.

See Fig. 8

To reinstall, line up setscrew with flat of the motor shaft and secure into position with the blade assembly flush to the end of the shaft.

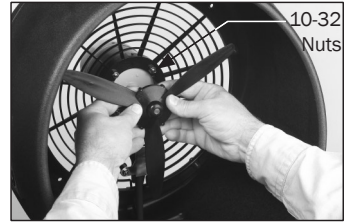

Fig. 8

Accessing The Motor

Disconnect the electrical power. After removing the atomizing ring, front guard assembly and blade assembly, use a 3/8" nut driver or wrench to remove the four 10-32 nuts behind the blade assembly securing the motor to rear guard.

See Fig. 8

Pump

Disconnect the electrical power.

With a Phillips screwdriver, remove the sump cover screws and the pump support screws. **See Fig. 9** Disconnect the plumbing on top of the pump and un-wire the pump's electrical cord that leads inside the ON/OFF Switch Box. Reinstall in the reverse order. **Note:** Only finger tighten the brass tube fitting when threading it into the top of the pump.

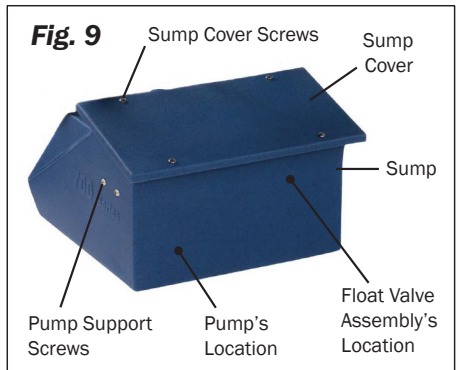

Fig. 9

PART IDENTIFICATION



	DESCRIPTION	PART NO.
1	Atomizing Ring	400-001
2	Front Guard	400-002
3	Motor 1/20hp 115V	400-110
4	Rear Guard	400-127
5	Blade Assembly	400-128
6	Housing	400-100
7	SST Support (lower)	a-620
8	SST Water Feed Tube	400-130
9	Pivot Location	NA
10	Sump	400-131
11	Float Valve Assembly	400-012
12	Flow Control Valve	400-016
13	SST Support (upper)	a-620
14	Pump	400-134
15	Pump Bracket	622
17	115V Toggle Switch	109
18	Switch Box	82
19	Switch Box Cover	85
21	Drain Barb Fitting	400-114
22	Drain Hose	400-089
23	1/4" Water Tubing	W-14
24	Garden Hose Connect	W-2





ONE YEAR LIMITED WARRANTY

AquaFog and accessories are warranted to the original purchaser against defects in material and workmanship under normal use for one full year from date of purchase. Any part determined to be defective and returned to the manufacturer, shipping cost prepaid, will be repaired or replaced at Jaybird Manufacturing, Inc.'s discretion without charge. Proof of purchase date and an explanation of the problem or complaint must accompany the returned portion of the machine.

Jaybird Manufacturing, Inc. reserves the right to verify the legitimacy of claimed defects. The provisions of this warranty do not apply to damage resulting from direct or indirect misuse, negligence, accident, lack of maintenance, or unauthorized repairs or alterations which affect the machine's performance or reliability.

LIMITATIONS OF LIABILITY. TO THE EXTENT ALLOWABLE UNDER APPLICABLE LAW, JAYBIRD MANUFACTURING, INC.'S LIABILITY FOR DEATH, INJURIES TO PERSONS OR PROPERTY, OR FOR CONSEQUENTIAL OR INCIDENTAL DAMAGES ARISING FROM THE USE OF OUR EQUIPMENT IS EXPRESSLY DISCLAIMED. JAYBIRD MANUFACTURING, INC.'S LIABILITY IN ALL EVENTS IS LIMITED TO, AND SHALL NOT EXCEED, THE PURCHASE PRICE PAID. NO OTHER WARRANTY, EXPRESSED OR IMPLIED, IS AUTHORIZED, INCLUDING WARRANTIES OF MERCHANTABILITY AND FITNESS FOR A PARTICULAR PURPOSE.

This warranty gives you specific legal rights, and you may also have other rights, which vary from state to state.

